

Relate^{5.0} ITE R hearing aid user guide

Relate^{5.0} ITE R
Easy Line Charger ITE



Relate[™]

This user guide is valid for:

Wireless hearing aids



Relate^{5.0} Platinum ITE R

Relate^{5.0} Gold ITE R

Charging accessory



Easy Line Charger ITE



Your hearing aid and charger details

- ① The hearing aids described in this user guide contain a built-in and non-removable rechargeable lithium-ion battery.
- ① Please also read safety information regarding handling rechargeable hearing aids (chapter 23).
- ① Your hearing aids operate between 2.4 GHz–2.48 GHz frequency range. When flying please check if flight operator requires devices to be switched into flight mode, see chapter 15.

Hearing aid model

Relate^{5.0} ITE R (Platinum / Gold)

Charging accessory

Easy Line Charger ITE

Thank you for choosing these hearing aids.

Please read the User guide carefully to make sure that you understand and get the best out of your hearing aids. Training is not required for handling of this device. A hearing care professional will help setup the hearing aids to your individual preferences during the sales consultation.

For more information regarding features, benefits, setup, use and maintenance or repairs of your hearing aid and accessories – contact your hearing care professional or manufacturer representative. Additional information can be found in the Datasheet of your product.

Table of contents

1. Quick guide	7
2. Parts of the hearing aid and charger	10
3. Preparing the charger.....	15
4. Charging the hearing aids	16
5. Left and right hearing aid markings	21
6. Putting on the hearing aid	22
7. Removing the hearing aid.....	23
8. Push button.....	25
9. On/Off	28
10. Tap control.....	29
11. Connectivity overview.....	30
12. Hearing Remote app overview.....	31
13. Initial pairing.....	32
14. Phone calls	35
15. Flight mode.....	38
16. Rebooting your hearing aid	40
17. Environmental conditions.....	41
18. Care and maintenance	43
19. Service and warranty	47
20. Compliance information.....	49

21. Information and explanation of symbols	55
22. Troubleshooting.....	62
23. Important safety information	67
Tinnitus Masker.....	92

1. Quick guide

Charging your hearing aids

- ❶ Before using your hearing aid for the first time, it is recommended to charge it for 3 hours.

After placing your hearing aids in the charger, the indicator light on the charging points will show the charging status. When fully charged the indicator light will turn solid green.

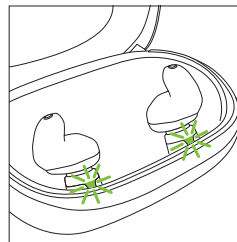

Left and right hearing aid markings



Blue or white marking for **left** hearing aid.



Red marking for **right** hearing aid.

Push button with indicator light

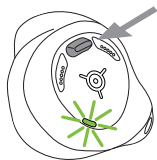

The push button has several functions, the primary function is as an on/off switch. Together with your hearing care professional, you can decide if it also allows for volume control and/or program change. This is indicated in your "Getting Started Guide".

Phone calls: If connected to a Bluetooth® enabled phone, a short press will accept and a long press will reject an incoming call.

On/Off: Press the button for 4 seconds until the indicator light blinks.

On: indicator light is solid green

Off: indicator light is solid red

Enter flight mode: When the device is off, press and hold the push button for approximately 10 seconds until the indicator light is solid orange. Then release the button.

Tap Control:

If paired with a Bluetooth® enabled device, multiple functions can be accessed using Tap Control, please refer to chapter 10.

This is also indicated in your individual instructions.

To use Tap Control, tap the ear twice.

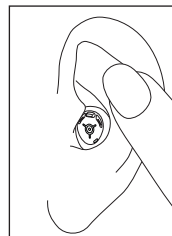

2. Parts of the hearing aid and charger

- 1 **Custom-made shell**
- 2 **Microphone protectors** - sound enters your hearing aids through the microphones, protectors protect microphones from dirt & debris
- 3 **Charging contacts**
- 4 **Push button** is primarily an on/off switch, and can also be configured by your HCP to perform other functions.
- 5 **Removal handle*** - assists in removing very small hearing aids from the ear canal
- 6 **Indicator light** - for battery status

*Applicable only for the models with this specific option.

The following pictures show the hearing aid model and charger described in this user guide.

Relate^{5.0} ITE R

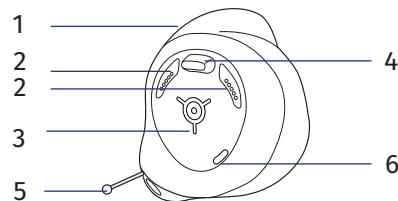

Parts of the charger

- 1 Charger case lid
- 2 Charging points - for hearing aids
- 3 Charging indicator lights - for charging status
- 4 USB connection - to external power supply

External power supply

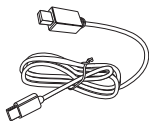

USB cable

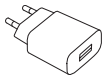

Power adapter

Easy Line Charger ITE

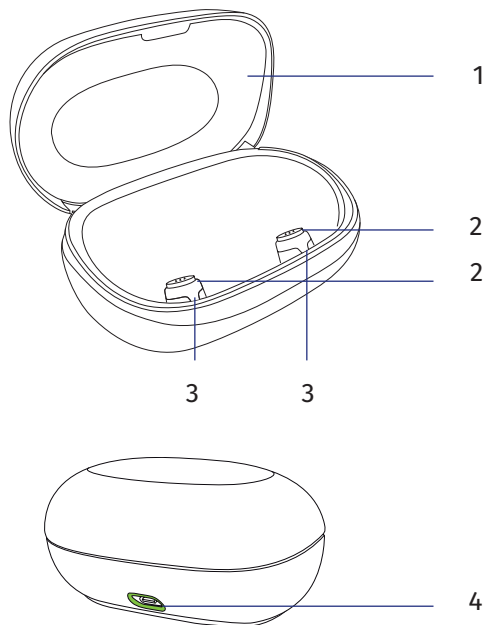

Power specification

Power supply input voltage	100-240 VAC, 50/60 Hz, current 0.25 A
Power supply output voltage	5 VDC +/-5%, current 1 A
Charger input voltage	5 VDC +/-10%, current 1 A
USB cable specifications	5 V min. 1 A, USB-A to USB-C, maximum length 3 m

3. Preparing the charger

Connecting to the power supply

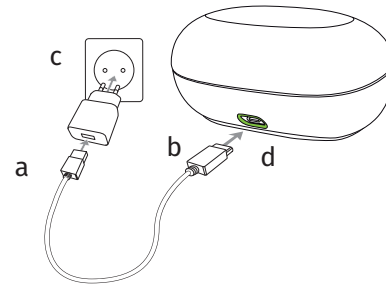

- Plug the larger end of the charging cable into the power adapter.
- Plug the smaller end into the USB port on the charger.
- Plug the power adapter into a power outlet.
- The indicator light around the USB port is green when the charger is connected to the power supply.
- Make sure you have access to the power adapter during charging.

4. Charging the hearing aids

- ① Low power: You will hear two beeps when the hearing aid battery is low. You will have approximately 60 minutes before you have to charge the hearing aids, after this time the hearing aid automatically shuts down (this can vary, depending on the hearing aid settings).
- ① The hearing aid contains a built-in and non-removable rechargeable lithium-ion battery.
- ① Before using your hearing aid for the first time, it is recommended to charge it for 3 hours.
- ① The hearing aid must be dry before charging, see chapter 18.
- ① Please ensure to charge the hearing aid within operating temperature range:
+5 to +40 °C (+41 to +104 °F)

⚠ Always make sure that the hearing aids and charger are dry and clean before charging.

Please refer to chapter 3 for how to set up the charger.

1.

Place the charging contacts of the hearing aids onto the charging points of the charger.

For easier identification and usage after charging, we recommend placing the right hearing aid on the right charging point and the left one on the left charging point. The hearing aids will automatically switch off once placed onto the charging points.

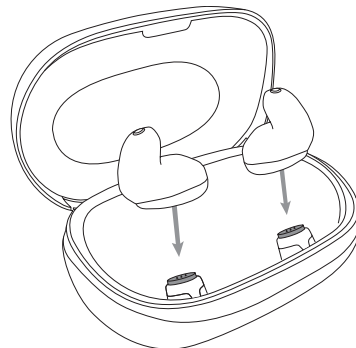



2.

The indicator light on the charging point will show the charging status. When fully charged the indicator light turns solid green.

The charging process will automatically stop when the batteries are fully charged, so the hearing aids can be safely left in the charger. It can take up to 3 hours to charge the hearing aids. The charger lid shall be closed while charging.

Charging status

Charger indicator light	Charging status	Comments
	Charging	The charger is connected to the power outlet and hearing aids are being charged.
	Fully charged	Charger is connected to the power outlet and the hearing aids are fully charged.
	Charging error	Ensure that charging contacts of the hearing aids and the charging points in the charger are clean. Place the hearing aids correctly (lying flat) on the charging points. If that does not help, contact your hearing care professional.
No indicator light	No power	Connect the charger to the power outlet to charge the hearing aids.

3.

Remove the hearing aids from the charging points by lifting them out of the charger.

The hearing aid can be set to switch on automatically when removed from the charger. The indicator light on the hearing aid starts blinking. The solid green light indicates the hearing aid is ready for use. The light will turn off after approximately 3 seconds.

To switch off the charger, remove the power supply from the power outlet.

- ① Turn off your hearing aid before inserting it in the disconnected charger to store it.

5. Left and right hearing aid markings

There is a left (L) and right (R) marking on the hearing aids. The mark is located on the shell:

- blue "L" mark on the left hearing aid
- red "R" mark on the right hearing aid

If the shell of the hearing aid is black, the "L" mark is white for visibility reasons.

You can also select a blue shell for the left device and a red shell for the right device.



Blue marking for left hearing aid.



Red marking for right hearing aid.

6. Putting on the hearing aid

Take your hearing aid up to your ear and place the custom-made shell part into your ear canal.

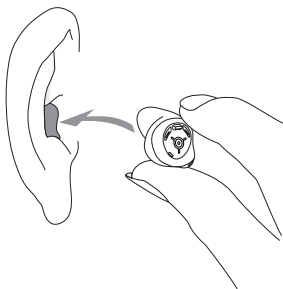

7. Removing the hearing aid

7.1 Removing the hearing aid without a removal handle

1.

Put your thumb behind your lobe and gently press your ear upward to push the hearing aid out of the canal. In order to help it along, make chewing movements with your jaw.

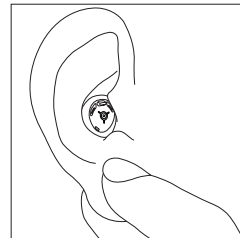

2.

Grasp the protruding hearing aid and remove it.

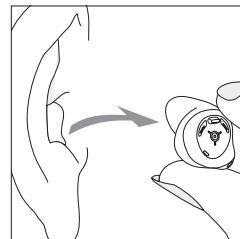

7.2 Removing the hearing aid with a removal handle

Hold the removal handle and carefully pull the hearing aid up and out of the ear.

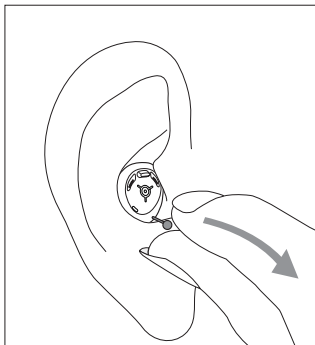

8. Push button

The push button has several functions, the primary function is as an on/off switch. Together with your hearing care professional, you can decide if it also allows for volume control and/or program change.

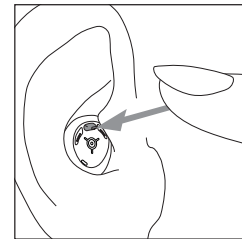





This is indicated in your individual “Getting Started Guide”. Please ask your hearing care professional for this printout.

If your hearing aid is paired with a Bluetooth® enabled phone, a short press on the push button will accept an incoming call and a long press will reject an incoming call – refer to chapter 14.

□ Push button as program control

If the push button has been configured as a program control, each time you push the button, you will move to a different hearing aid program.

Your hearing aids beep to indicate which program you are in.





Program setting	Beeps
Program 1 (e.g. automatic program)	 1 beep
Program 2 (e.g. speech in noise)	 2 beeps
Program 3 (e.g. telephone)	 3 beeps
Program 4 (e.g. music)	 4 beeps

□ Push button as volume control

If your push button has been configured as a volume control:

- Push the button to step through your volume levels

As you change the volume control, your hearing aids will beep.

Volume setting	Beeps
Suggested volume level	 1 beep
Turning volume up	 short beep
Turning volume down	 short beep
Maximum volume level	 2 beeps
Minimum volume level	 2 beeps

9. On/Off

Switch on hearing aid

The hearing aid can be configured to switch on automatically when removed from the charger. If this function is not configured, press and hold the push button for 4 seconds until the indicator light blinks. Wait until the solid green light indicates the hearing aid is ready.

Switch off hearing aid

Press and hold the push button for 4 seconds. Wait until the solid red light indicates the hearing aid is switched off.

- ① When you switch on the hearing aid, you may hear a start-up melody.

10. Tap control

If paired with a Bluetooth® enabled device, multiple functions can be accessed using Tap Control e.g. accept/end phone call, pause/resume streaming, start/stop voice assistant. This is indicated in your individual “Getting Started Guide”.

To use Tap Control, tap your ear twice.



11. Connectivity overview

The illustration below shows the connectivity options available for your hearing aid.

Bluetooth
enabled devices

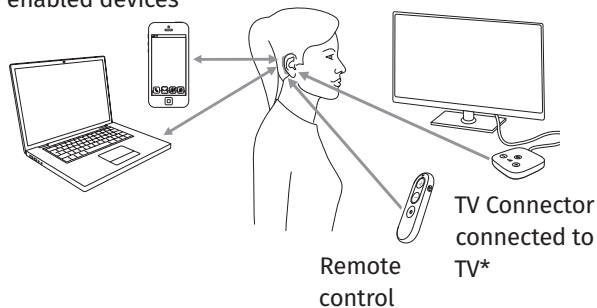

* The TV Connector can be connected to any audio source such as a TV, PC or hi-fi system.

12. Hearing Remote app overview

To learn more about the Hearing Remote app, please visit the webpage www.unitron.com/appguide.

To install the Hearing Remote app, please scan the QR code

For iPhone® / iPad®:



For Android™ OS:



iPhone®/iPad® is a trademark of Apple Inc., registered in the U.S. and other countries and regions.
Android™ is a trademark of Google LLC.

13. Initial pairing

If you use the Hearing Remote app to pair your hearing aids with your phone, you can skip the instructions in chapter 13.1. The pairing happens automatically through the app.

13.1 Initial pairing to Bluetooth® enabled device

① It is only necessary to perform the pairing procedure once with each device featuring Bluetooth® wireless technology. After the initial pairing, your hearing aids will connect automatically to the device. This can take up to 2 minutes.

1.

On your device (e.g. a phone), ensure that Bluetooth® wireless technology is enabled and search for Bluetooth® enabled devices in the connectivity setting menu.

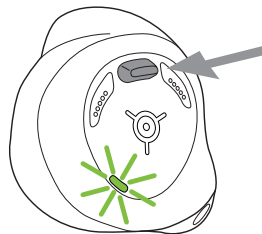

2.

Switch on both hearing aids. You now have 3 minutes to pair your hearing aids with your device.

3.

Your device shows a list of Bluetooth® enabled devices. Select the hearing aid from the list to simultaneously pair both hearing aids. A beep heard in the hearing aids confirms successful pairing.

① Consult your phone user guide for instructions on pairing a Bluetooth device with your phone.

13.2 Connecting to the device

After your hearing aids have been paired to your device, they will automatically connect again when switched on.

- ① The connection will be maintained as long as the device remains ON and within range.
- ① Your hearing aid can be connected to up to two devices and paired to up to eight devices.

After the device goes out of range, you can trigger an automatic reconnection by pressing the push button on the hearing aid for less than 2 seconds.

14. Phone calls

Your hearing aids connect directly with Bluetooth® enabled phones. When paired and connected to your phone, you will hear notifications and the caller's voice directly in your hearing aids. Phone calls are "hands free", which means that your voice is picked up by the hearing aid's microphones and transmitted back to the phone.



14.1 Making a call

Enter the phone number and press the dial button. You will hear the dialing tone through your hearing aids. Your voice is picked up by the hearing aid microphones and transmitted to the phone.

14.2 Accepting a call

When receiving a call, an incoming call notification will be heard in the hearing aids (e.g. ring tone or voice notification).

The call can be accepted by tapping your ear twice (if enabled), a short press on the push button on the hearing aid (less than 2 seconds) or directly on your phone.

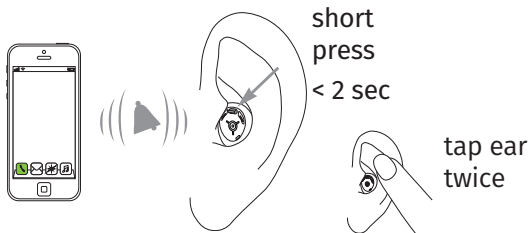

14.3 Ending a call

A call can be ended by tapping your ear twice (if Tap Control is enabled), a long press on the push button on the hearing aid (more than 2 seconds), or directly on your phone.

14.4 Rejecting a call

An incoming call can be rejected by a long press on the push button on the hearing aid (more than 2 seconds) or directly on your phone.

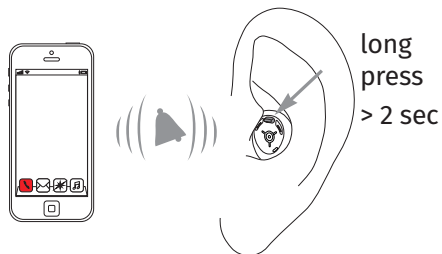

15. Flight mode

Your hearing aids operate between 2.4 GHz–2.48 GHz frequency range. When flying, some operators require all devices to be switched into flight mode. Entering flight mode will not disable normal hearing aid functionality, only the Bluetooth® connectivity functions.

15.1 Enter flight mode

To disable the wireless function and enter flight mode in each hearing aid:

1.

Turn off the hearing aids (refer to chapter 9).

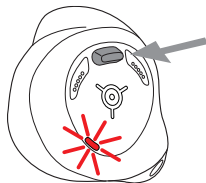

2.

Press and hold the push button for approximately 10 seconds until the indicator light is solid orange. Then release the button.

In flight mode, your hearing aid cannot connect directly to your phone.

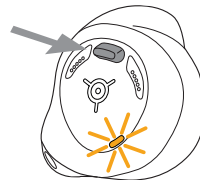

15.2 Exit flight mode

To enable the wireless function again and exit flight mode in each hearing aid, switch the hearing aid off and then on again (refer to chapter 9).

16. Rebooting your hearing aid

Use this technique if your hearing aid is in an error state. This will not remove or delete any program or settings.

Press the push button for at least 15 seconds. It does not matter if the hearing aid is switched on or off before you start pressing the button. After 15 seconds the indicator light on the hearing aid blinks green and then turns solid green. The hearing aid is ready to use.

17. Environmental conditions

The product is designed so that it functions without problems or restrictions if used as intended, unless otherwise noted in this user guide.

Please ensure to use, charge, transport and store the hearing aids and charger according to the following conditions:

	Charging and operating	Transport	Storage
Temperature	+5 to +40 °C (+41 to +104 °F)	-20 to +60 °C (-4 to +140 °F)	-20 to +60 °C (-4 to +140 °F)
Humidity (non condensing)	0 to 90 %	0 to 93 %	0 to 93 %
Atmospheric pressure	500 to 1060 hPa	500 to 1060 hPa	500 to 1060 hPa

Prolonged storage at temperatures lower than 10 °C and higher than 30 °C may negatively affect the battery performance of the product.

These hearing aids are classified as IP68. This means that they are water and dust resistant and designed to withstand daily life situations. They can be worn in the rain but should not be fully submerged in water or used when taking a shower, swimming or other water activities. These hearing aids should never be exposed to chlorinated water, soap, salt water or other liquids with a chemical content.

This charger is classified as IP21. This means that the charger is protected from vertically falling drops of water e.g. condensation. IP21 is satisfied when the charger lid is closed.

Please ensure to charge the hearing aids regularly during long-term storage. If the device has been subject to storage and transport conditions outside of the recommended use conditions, wait 15 minutes before starting the device.

18. Care and maintenance

Expected Service Life

The hearing aids and the compatible charger have the expected service life of five years. The devices are expected to remain safe for use for this duration.

Commercial service period

Routine and diligent care of your hearing aids and charger will contribute to the outstanding performance for the duration of the expected service life of your devices.

Sonova AG will provide a minimum of a five year repair service period after the respective hearing aid and essential components have been phased out of the product portfolio.

Please use the following specifications as a guideline. For further information regarding product safety, see chapter 23.

General information

Before using hair spray or applying cosmetics, you should remove your hearing aid from your ear, because these products may damage it.

Make sure that you always completely dry your hearing aid after use. Store the hearing aid in a safe, dry and clean place.

Your hearing aids are resistant to water, sweat and dust under the following conditions:

- After exposure to water, sweat or dust, the hearing aid is cleaned and dried.
- The hearing aid is used and maintained as described in this user guide.

 Always make sure that the charger is disconnected from the power mains before cleaning.

Daily

Hearing aid: Daily cleaning and the use of a drying system is recommended. Never use cleaning agents such as household detergents, soap, etc. for cleaning your hearing aids. It is not recommended to rinse with water. Clean the area around the push button and the charging contacts with a soft brush, and all other surfaces with a lint free cloth or a soft brush.

If your hearing aid is performing weakly or fails to operate, clean the microphone protectors with a soft brush, and clean or replace the wax guard system. If your hearing aid fails to operate after you have correctly cleaned or replaced your wax protection system, contact your hearing care professional for advice.

Charger: Make sure that the charger points are clean by cleaning the contact surfaces with a soft brush. Never use cleaning agents such as household detergents, soap, etc. for cleaning your charger. Do not rinse your charger with water.

Weekly

Hearing aid: For more in-depth maintenance instructions or for more than basic cleaning, please see your hearing care professional.

Charger: Remove dust or dirt from the charger points with a soft brush.

19. Service and warranty

Local warranty

Please ask the hearing care professional where you purchased your hearing aid and charger about the terms of the local warranty.

International warranty

Sonova AG offers a one year limited international warranty, valid from the date of purchase. This limited warranty covers manufacturing and material defects in the hearing aids and charger only. The warranty only comes into force if a proof of purchase is shown.

The international warranty does not affect any legal rights that you might have under applicable national legislation governing sale of consumer goods.

Warranty limitation

This warranty does not cover damage from improper handling or care, exposure to chemicals or undue stress. Damage caused by third parties or non-authorized service centers renders the warranty null and void. This warranty does not include any services performed by a hearing care professional in their office.

Serial numbers

Hearing aid left side: _____

Hearing aid right side: _____

Charger: _____

Date of purchase: _____

Authorized hearing care professional (stamp/
signature):

20. Compliance information

Europe:

Declaration of Conformity for the Hearing Aid

Hereby Sonova AG declares that this product meets the requirements of the Medical Devices Regulation (EU) 2017/745 as well as the Radio Equipment Directive 2014/53/EU. The full text of the EU Declaration of Conformity can be obtained from the manufacturer: www.sonova.com/en/certificates.

Declaration of Conformity for the Charging Accessories

Hereby Sonova AG declares that this product meets the requirements of the Medical Devices Regulation (EU) 2017/745 and the UK Medical Device Regulation 2002.

Australia/New Zealand:



R-NZ

Indicates a device's compliance with applicable Radio Spectrum Management's (RSM) and Australian Communications and Media Authority (ACMA) regulatory arrangements for the legal sale in New Zealand and Australia.

The compliance label R-NZ is for radio products supplied in the New Zealand market under conformity level A1.

The wireless models listed on page 2 are certified under:

Relate^{5.0} ITE R:

USA FCC ID: KWC-VTI (left)
 FCC ID: KWC-VTJ (right)

Notice 1:

This device complies with Part 15 of the FCC Rules and with RSS-210 of Industry Canada. Operation is subject to the following two conditions:

- 1) this device may not cause harmful interference, and
- 2) this device must accept any interference received, including interference that may cause undesired operation.

Notice 2:

Changes or modifications made to this device not expressly approved by Sonova AG may void the FCC authorization to operate this device.

Notice 3:

The device is in compliance with the portable RF exposure requirements listed on RSS 102 Issue 6 and FCC 47 CFR Part 2.1093 for a distance of use equal or greater than 0.5mm.

Notice 4:

This device has been tested and found to comply with the limits for a Class B digital device, pursuant to Part 15 of the FCC Rules and ICES-003 of Industry Canada.

These limits are designed to provide reasonable protection against harmful interference in a residential installation. This device generates, uses and can radiate radio frequency energy and, if not installed and used in accordance with the instructions, may cause harmful interference to radio communications. However, there is no guarantee that interference will not occur in a particular installation. If this device does cause harmful interference to radio or television reception, which can be determined by turning the equipment off and on, the user is encouraged to try to correct the interference by one or more of the following measures:

- Reorient or relocate the receiving antenna.
- Increase the separation between the device and receiver.
- Connect the device into an outlet on a circuit different from that to which the receiver is connected.
- Consult the dealer or an experienced radio/TV technician for help.

Please keep at least 20 cm separation distance between the charger and the human body during operation.

Radio information table of your wireless hearing aid

Antenna type	Modified dipole antenna
Operation frequency	2.4 GHz – 2.48 GHz
Modulation	GFSK, Pi/4-DPSK, 8-DPSK, GMSK
Radiated power	< 2.5 mW

Bluetooth®

Core version	Bluetooth® Core 5.3, Dual-Mode
Profiles supported	HFP (Hands-free profile), A2DP

Electromagnetic emissions

Manufacturer's Declaration: The hearing aids and charging accessories are intended for use in the electromagnetic environments listed below. The user should assure that they are used in such environments.

Emissions Test	Compliance	Electromagnetic environment guidance
RF emissions CISPR 11	Group 1	The hearing aids and charging accessories generate or use RF energy only for their internal functioning. Therefore, the RF emissions are very low and are not likely to cause any interference to nearby electronic equipment.
RF emissions CISPR 11	Class B	The hearing aids and charging accessories are suitable for use in domestic establishment and in establishment directly connected to a low voltage power supply network which supplies buildings used for domestic purposes.

Electromagnetic immunity

Immunity Test	IEC60601-1-2 Test Level	Compliance Level
Electrostatic Discharge (ESD) IEC 61000-4-2	+/- 8 kV contact +/- 2 kV, +/- 4 kV, +/- 8 kV, +/- 15 kV air	+/- 8 kV contact +/- 2 kV, +/- 4 kV, +/- 8 kV, +/- 15 kV air
Radiated RF Electromagnetic Field Immunity Test IEC 61000-4-3	10 V/m 80 MHz – 2.7 GHz 80% AM at 1 kHz	10 V/m 80 MHz – 2.7 GHz 80% AM at 1 kHz
	9 V/m; 710, 745, 780 MHz; Pulse modulation 18 Hz	9 V/m; 710, 745, 780 MHz; Pulse modulation 18 Hz
Proximity Magnetic Field IEC 61000-4-3	9 V/m; 5240, 5500, 5785 MHz; Pulse modulation 217 Hz 27 V/m; 385 MHz; Pulse modulation 18 Hz	9 V/m; 5240, 5500, 5785 MHz; Pulse modulation 217 Hz 27 V/m; 385 MHz; Pulse modulation 18 Hz
	28 V/m; 450 MHz FM +/- 5 kHz deviation; 1 kHz sine	28 V/m; 450 MHz FM +/- 5 kHz deviation; 1 kHz sine
	28 V/m; 810, 870, 930 MHz; Pulse modulation 18 Hz	28 V/m; 810, 870, 930 MHz; Pulse modulation 18 Hz
	28 V/m; 1720, 1845, 1970, 2450 MHz; Pulse modulation 217 Hz	28 V/m; 1720, 1845, 1970, 2450 MHz; Pulse modulation 217 Hz

Immunity Test	IEC60601-1-2 Test Level	Compliance Level
----------------------	--------------------------------	-------------------------

Rated power frequency magnetic fields IEC 61000-4-8		
---	--	--

30 A/m 50 Hz or 60 Hz		
--------------------------	--	--

30 A/m 50 Hz or 60 Hz		
--------------------------	--	--

21. Information and explanation of symbols



With the CE symbol, Sonova AG confirms that this product – including accessories – meets the requirements of the Medical Devices Regulation (EU) 2017/745. The numbers after the CE symbol correspond to the code of certified institutions that were consulted under the above-mentioned regulation and directive.



With the CE symbol, Sonova AG confirms that this product – including accessories – meets the requirements of the Medical Devices Regulation MDR 2017/745 as well as the Radio Equipment Directive 2014/53/EU.



This symbol indicates that the products described in these user instructions adhere to the requirements for an applied part of Type B of EN 60601-1. The surface of the hearing aid is specified as an applied part of Type B.



Indicates the medical device manufacturer, as defined in the Medical Devices Regulation (EU) 2017/745.



Indicates the date when the medical device was manufactured.



With the UK Conformity Assessed mark, Sonova AG confirms that the product is conform to applicable Great Britain legislations.



Indicates the Authorized representative in the European Union. The EU REP is also the importer to the European Union.



Indicates the Authorized representative in the European Community. The EC REP is also the importer to the European Union.



This symbol indicates that it is important for the user to read and take into account the relevant information in these user guides.



This symbol indicates that it is important for the user to pay attention to the relevant warning notices in these user guides.



Important information for handling and product safety.



Indicates the manufacturer's serial number so that a specific medical device can be identified.



Indicates the manufacturer's catalogue number so that the medical device can be identified.



This symbol confers that the electromagnetic interference from the device is under limits approved by the US Federal Communications Commission.



This symbol indicates that it is important for the user to pay attention to the relevant warning notices related to batteries in these user guides.



This symbol indicates that this is a Prescription Device. CAUTION: U.S. Federal law restricts this device to sale by or on the order of a physician or hearing care professional (for US only).



Indicates a device's compliance with applicable Radio Spectrum Management's (RSM) and Australian Communications and Media Authority (ACMA) regulatory arrangements for the legal sale in New Zealand and Australia.



The Bluetooth® word mark and logos are registered trademarks owned by Bluetooth SIG, Inc. and any use of such marks by Sonova is under license. Other trademarks and trade names are those of their respective owners.



Indicates that the device is a medical device.



An indication that electronic instructions for use are available.



Japanese mark for certified radio equipment.

IP68

Ingress Protection Rating. IP68 rating indicates that the hearing aid is water and dust resistant. It survived continuous immersion in 1 meter of water for 60 minutes and 8 hours in a dust chamber as per the IEC60529 standard.

IP21

Ingress Protection Rating. IP21 rating indicates that the device is protected against solid foreign objects of 12,5 mm diameter and is additionally protected against vertically falling water drops.



Indicates the temperature limits to which the medical device can be safely exposed.



Indicates the range of humidity to which the medical device can be safely exposed.



Indicates the range of atmospheric pressure to which the medical device can be safely exposed.



During transportation keep dry.



This symbol indicates a device that is not safe to use in magnetic resonance (MR) environment (e.g. during an MRI scan).



The symbol with the crossed-out garbage bin is to make you aware that this hearing aid as well as the charger may not be thrown away as normal household waste. Please dispose of old or unused hearing aids and charger, at waste disposal sites intended for electronic waste, or give your hearing aid and charger to your hearing care professional for disposal. Proper disposal protects the environment and health.

Symbols applicable to the European power supply only



Power supply with double isolation.



Device designed for indoor use only.



Safety isolating transformer, short circuit proof.

22. Troubleshooting

Cause	What to do
Problem: Hearing aid not functioning.	
Blocked sound outlet.	Clean sound outlet, e.g. replace wax guard system.
Hearing aid switched off.	Press push button for 4 seconds. If your hearing aid does not switch on, place it onto the charging point for at least 30 seconds to restart.
Battery fully discharged.	Charge hearing aid (chapter 4).
Problem: Hearing aid whistles.	
Hearing aid not inserted correctly into ear.	Insert hearing aid correctly (chapter 6).
Cerumen in ear canal.	Contact your ENT/GP or hearing care professional.
Problem: Hearing aid too loud.	
Volume too loud.	Decrease volume if volume control available (chapter 8).

Cause	What to do
Problem: Hearing aid not loud enough or distorted.	
Volume too low.	Increase volume if volume control available (chapter 8).
Low battery.	Charge hearing aid (chapter 4).
Blocked sound outlet.	Clean sound outlet, e.g. replace wax guard system.
Hearing has changed.	Contact your hearing care professional.
Microphone protectors clogged.	Clean with a soft brush. If it does not help, contact your hearing care professional.
Problem: Hearing aid plays two beeps.	
Indication for low battery.	Charge hearing aid (chapter 4).
Problem: Hearing aid will not switch on.	
Battery fully discharged.	Charge hearing aid (chapter 4).

Cause	What to do
Problem: Indicator light on the charging point does not light up when hearing aid placed on the charging point.	
Hearing aid not inserted correctly into the charger.	Insert hearing aid correctly into the charger (chapter 4).
Charger is not connected to the power outlet.	Connect the charger to the power outlet.

Problem: Indicator light on the charging point is solid red while hearing aid is in the charger.	
Charging contact on the hearing aid or/and charging point in the charger are dirty.	Ensure that charging contacts and charging points are clean (chapter 18).
Hearing aid not inserted correctly into the charger.	Insert hearing aid correctly into the charger (chapter 4).
The hearing aid stopped charging because the battery couldn't fully charge within 3 hours.	Remove the hearing aids from the charger and put them back again to start the new charging cycle.
Faulty battery.	Contact your hearing care professional.

Cause	What to do
Problem: Indicator light on hearing aid does not switch on when hearing aid is removed from charger.	
"Auto On" feature is disabled.	Switch on the hearing aid (chapter 9).

Problem: Battery does not last the whole day.	
Shortened battery life.	Contact your hearing care professional. A battery replacement may be required.

Problem: Phone call function does not work.	
Hearing aid is in flight mode.	Switch hearing aid off and then on again (chapter 9).
Hearing aid not paired to the phone.	Pair hearing aid to the phone (chapter 13).

Cause	What to do
<p>Problem: Charging does not start (but indicator light around the charger USB port lights up green when the charger is connected to the power outlet).</p>	
<p>Hearing aid not placed correctly onto the charging points.</p>	<p>Place hearing aid correctly onto the charging points (chapter 4).</p>

① If the problem persists, contact your hearing care professional for assistance.

For further information please check www.unitron.com/global/en_us/help-and-support.

23. Important safety information

Please read the relevant safety information and limitations-of-use information on the following pages before using your hearing aid and charger.

Intended use

The hearing aid is intended to amplify and transmit sound to the ear and thereby compensate for impaired hearing.

The Tinnitus feature is intended for use by people with tinnitus who also desire amplification. It provides supplementary noise stimulation which can help defocus the user's attention from their tinnitus.

The charger is intended to charge the battery of the rechargeable hearing aids.

Intended user

Hearing aid: Intended for people with hearing loss using a hearing aid and their caregivers. A hearing care professional is responsible for adjusting the hearing aid.

Charger: Intended for people with hearing loss using the compatible rechargeable hearing aid and their caregivers, hearing care professional.

Intended patient population

Hearing aids: The device is intended for patients from 18 years of age which fulfill the clinical indication for this product.

Tinnitus feature: The Tinnitus Software feature is intended for patients from 18 years of age who fulfill the clinical indication for this software feature.

Charger: The intended patient population for the chargers is the intended patient population of the compatible hearing aids.

Intended Medical Indication

Hearing aid: Clinical indications for the use of hearing aids are:

- Presence of organic hearing loss
 - Uni - or bilateral
 - Conductive, sensorineural or mixed
 - Grades: mild to profound

Indications for the use of the Tinnitus features are:

- Presence of a chronic tinnitus (> 3 months, after occurrence) in addition to the presence of a hearing loss

Charger: Please note, indications are not derived from charger, but from the compatible hearing aids.

Intended Medical Contraindications

Contraindications for the use of hearing aids and Tinnitus feature are:

- Acute tinnitus (< 3 months, after occurrence)

- Deformity of the ear (i.e. closed ear canal)
- Neural hearing loss (retro-cochlear pathologies such as absent/non-viable auditory nerve)

Charger: Please note, contraindications are not derived from the charging accessories, but from the compatible hearing aids.

Clinical benefit

Hearing aids: Improvement of speech understanding.

Tinnitus feature provides supplementary noise stimulation which can help defocus the user's attention from their tinnitus.

Charger: The charger itself does not provide a direct clinical benefit. An indirect clinical benefit is provided by enabling the parent device (rechargeable hearing aids) to achieve their intended purpose.

Side effects:

Hearing aid: Physiological side-effects of hearing aids like tinnitus, dizziness, wax build up, too much pressure, sweating or moisture, blisters, itching and/or rashes, plugged or fullness and their consequences like headache and/ or ear pain, may be resolved or reduced by your hearing care professional. Conventional hearing aids have the potential to expose patients to higher levels of sound exposure, which might result in threshold shifts in the frequency range affected by acoustic trauma.

Charger: Please note, side effects are not derived from the charger, but from the compatible hearing aids.

The primary criteria for the referral of a patient for a medical or other specialist opinion and / or treatment are as follows:

- Visible congenital or traumatic deformity of the ear;
- History of active drainage from the ear in the previous 90 days;

- History of sudden or rapidly progressive hearing loss in one or both ears within the previous 90 days;
- Acute or chronic dizziness;
- Audiometric air-bone gap equal to or greater than 15 dB at 500 Hz, 1000 Hz and 2000 Hz;
- Visible evidence of significant cerumen accumulation or a foreign body in the ear canal;
- Pain or discomfort in the ear;
- Abnormal appearance of the eardrum and ear canal such as:
 - Inflammation of the external auditory canal,
 - Perforated eardrum,
 - Other abnormalities which the hearing care professional believes are of medical concern.

The hearing care professional may decide that referral is not appropriate or in the best interests of the patient when the following applies:

- When there is sufficient evidence that the condition has been fully investigated by a medical specialist and any possible treatment has been provided;
- The condition has not worsened or changed significantly since the previous investigation and / or treatment.

If the patient has given their informed and competent decision not to accept advice to seek a medical opinion, it is permissible to proceed to recommend appropriate hearing aid systems subject to the following considerations:

- The recommendation will not have any adverse effects on the patients health or general well being;
- The records confirm that all necessary considerations about the patient's best interests have been made.

If legally required, the patient has signed a disclaimer to confirm that the referral advice has not been accepted and that it is an informed decision.

A hearing aid will not restore normal hearing and will not prevent or improve a hearing impairment resulting from organic conditions. Infrequent use of a hearing aid does not permit a user to attain full benefit from it. The use of a hearing aid is only part of hearing habilitation and may need to be supplemented by auditory training and instruction in lipreading.

Hearing aids are suitable for the home healthcare environment and due to their portability it may happen that they are used in professional healthcare facility environments like physician offices, dental offices etc.

Feedback, poor sound quality, too loud or too soft sounds, inadequate fitting or problems when chewing or swallowing, can be resolved or improved during the fine-tuning process at the fitting procedure by your hearing care professional.

Any serious incident that has occurred in relation to the hearing aid, should be reported to the manufacturer representative and the competent authority of the state of residence. The serious incident is described as any incident that directly or indirectly led, might have led or might lead to any of the following:

- The death of a patient, user or other person;
- The temporary or permanent serious deterioration of a patient's, user's or other person's state of health;
- A serious public health threat.

To report an unexpected operation or event, please contact the manufacturer or a representative.

23.1 Hazard warnings

- ⚠ Your device operates between 2.4 GHz–2.48 GHz frequency range. When flying please check if flight operator requires devices to be switched into flight mode, see chapter 15.
- ⚠ Changes or modifications to the hearing aid and charging accessory that were not explicitly approved by Sonova AG are not permitted. Such changes may damage your ear or the hearing aid.
- ⚠ Do not use the hearing aids and charging accessories in explosive areas (mines or industrial areas with danger of explosions, oxygen-rich environments or areas where flammable anesthetics are handled). The devices are not ATEX certified.
- ⚠ If you feel pain in or behind your ear, if it is inflamed or if skin irritation and accelerated accumulations of earwax occur, please check with your hearing care professional or physician.
- ⚠ In very rare cases if not securely attached, a cerumen stop can remain in your ear canal

when removing the hearing aid from the ear. In the unlikely case that such part gets stuck in your ear canal, it is strongly recommended to see a physician for safe removal.

- ⚠ Hearing programs in the directional microphone mode reduce background noises. Please be aware that warning signals or noises coming from behind, e. g. cars, are partially or entirely suppressed.
- ⚠ The following is only applicable for persons with active implantable medical devices (i.e. pacemakers, defibrillators, etc.)
 - Keep the wireless hearing aid and charging device at least 15 cm (6 inches) away from the active implant. If you experience any interference do not use the devices and contact the manufacturer of the active implant. Please, note that the interference can also be caused by powerlines, electrostatic discharge, airport metal detectors etc.
 - Keep magnets at least 15 cm (6 inches) away from the active implant.

- ⚠ Use of accessories, transducers and cables other than those specified or provided by the manufacturer of this equipment could result in increased electromagnetic emissions or decreased electromagnetic immunity of this equipment and result in improper operation.
- ⚠ Portable RF communications equipment (including peripherals such as antenna cables and external antennas) should be used no closer than 30 cm (12 inches) to any part of the hearing aids, including cables specified by the manufacturer. Otherwise, degradation of the performance of this equipment could result.
- ⚠ Avoid strong physical impacts to the ear when wearing in-the-ear hearing aids. The stability of in-the-ear shells is designed for normal use. A strong physical impact to the ear (e.g. during sports) may cause the in-the-ear shell to break. This may lead to perforation of the ear canal or ear drum.

After mechanical stress or shock to the hearing aid, please ensure that the hearing aid shell is intact before placing it in the ear.

- ⚠ Use of this equipment adjacent to or stacked with other equipment should be avoided because it could result in improper operation. If such use is necessary, this equipment and the other equipment should be observed to verify that they are operating normally.
- ⚠ The hearing aids (specially programmed for each hearing loss) must only be used by the intended person. They should not be used by any other person as they could damage hearing.
- ⚠ If you experience itching, redness, blisters, swelling, inflammation in or around your ears, inform your hearing care professional and contact your physician.

- ⚠ Patients implanted with magnetic externally programmable CSF shunt valves may have a risk of experiencing an unintended change in their valve setting when exposed to strong magnetic fields. The receiver (loudspeaker) of hearing aids contains static magnets. Keep a distance of 2 inches (approx. 5 cm) or more between the magnets and the site of the implanted shunt valve.
- ⚠ The majority of hearing aid users have a hearing loss for which a deterioration in hearing is not to be expected with regular use of a hearing aid in everyday situations. Only a small group of hearing aid wearers with hearing loss, may be at risk of deterioration in hearing after a long period of use.
- ⚠ Only use the device according to chapter 17 "Environmental conditions". Using the device otherwise may heat the hearing aid up to temperatures, which in the worst-case can lead to skin burns.

- ⚠ For charger, use only IEC 60950-1*, IEC 62368-1 or IEC60601-1 certified equipment with an output rating of 5 VDC. Max. 1A.
- ⚠ Do not touch the contacts of the charger when powered.
- ⚠ Only authorized personnel are allowed to open the charging accessory due to possible electrical hazard.
- ⚠ Charger and power supply must be protected against shocks. If the charger or power supply is damaged after a shock, the device must not be used anymore.
- ⚠ Always make sure that the hearing aids and charger are dry and clean. If the charger or power supply is damaged, the device must not be used anymore as it may cause electric shock.

*Note: this standard may not be valid anymore in your country, please refer to IEC 62368-1.

 Cables and cords wrapped around the neck may cause strangulation. Do not leave the device and its components unattended with children, individuals with cognitive impairment or pets.

 Special medical or dental examination including radiation described below, may adversely affect the correct functioning of your hearing aids. Remove and keep them outside the examination room/area before undergoing:

- Medical or dental examination with X-ray (also CT scan).
- Medical examinations with MRI/NMRI scans, generating magnetic fields.

Hearing aids don't need to be removed when passing security gates (airports etc.). If X-ray is used at all, it will be in very low doses, and will not affect the hearing aids.

 The device and its components contain acrylates or methacrylates. People who are sensitive to such substances may potentially experience an allergic skin

reaction. Stop using the device immediately if such a reaction occurs and contact your hearing care professional or physician.

 The volume of Tinnitus feature can be set to a level which could lead to permanent hearing damage when used for a prolonged period of time. Should the Tinnitus feature be set to such a level in your hearing aid, your hearing care professional will advise you of the maximum amount of time per day you should use the Tinnitus feature. The Tinnitus feature should never be used at uncomfortable levels



This device uses a lithium button/coin battery. These batteries are hazardous and can cause severe or fatal injuries in 2 hours or less if they are swallowed or placed inside any part of the body, whether the battery is used or new! Keep out of the reach of children, individuals with cognitive impairment, or pets. If you suspect that a battery was swallowed or placed inside any part of the body, immediately consult your physician without any delay.

23.2 Information on product safety

- ① Never immerse your hearing aid in water! Protect it from excessive moisture. Always remove your hearing aid before showering, bathing, or swimming, as the hearing aid contains sensitive electronic parts.
- ① Protect your hearing aid and your charging accessories from heat and sunlight (never leave near a window or in the car). Never use a microwave or other heating devices to dry your hearing aid or your charging accessories (due to risk of fire or explosion). Ask your hearing care professional about suitable drying methods.
- ① Make sure that you always completely dry your hearing aid after use. Store the hearing aid in a safe, dry and clean place.
- ① Do not drop your hearing aid or charging accessories! Dropping onto a hard surface can damage your hearing aid or charging accessories.
- ① Do not use your hearing aid and charging accessory in areas where electronic equipment is prohibited.
- ① Do not kink or buckle the removal handle. Repeated stress to the removal handle may cause it to break. In case of a broken removal handle, the battery door (if available) may exceptionally be used to carefully pull the hearing aid out of the ear canal. If you are not able to remove the hearing aid, contact your hearing care professional or physician.
- ① Only use approved chargers described in this user guide for charging your hearing aids, otherwise the devices may be damaged.

- ① If you are not using your hearing aid for a long period of time, store it in a box with a drying capsule or in a well ventilated location. This allows moisture to evaporate from your hearing aid and prevents a potential impact on its performance.
- ① Never wash the microphone inputs. Doing so could cause it to lose its special acoustic features.
- ① Do not place these rechargeable devices in your checked-in luggage when traveling by plane as they contain lithium-ion batteries. The devices should be placed in your carry-on/hand luggage.
- ① Ship the rechargeable devices according to local regulations as the devices contain lithium-ion batteries. For shipping, they are classified as dangerous goods. If in doubt ask the courier responsible for shipping how to ship the devices properly.

- ① Hearing aids and their parts should be kept out of reach of children and anyone who might swallow, choke on or otherwise cause injury to themselves with them. If swallowed consult a physician or hospital immediately as the hearing aid or its parts can be poisonous. In the event of choking immediately administer treatment or contact emergency services.
- ① These hearing aids are water resistant and not waterproof. They are designed to withstand normal activities and occasional accidental exposure to extreme conditions. Never immerse your hearing aid in water! These hearing aids are not specifically designed for extended periods of water submersion on a continual basis, that is worn in activities such as swimming or bathing. Always remove your hearing aid before these activities, as the hearing aid contains sensitive electronic parts.

- ① The usage of this device by children and individuals with cognitive impairment should be supervised at all times to ensure their safety.
- ① Always keep the USB socket of the device and the USB plug of the cable clean and dry. Foreign particles or moisture in the USB connection can lead to an electrical fault, which can heat up the USB connection and, in the worst case, cause it to melt. Use the provided cable to supply power to the device. If you notice the indicator light around the USB port of the device went off during charging, check the USB connection for proper conditions.

- ① Some internal components of the device contain nickel. Although not expected, exposure to nickel cannot be excluded. People who are sensitive to nickel may potentially experience an allergic skin reaction. Stop using the device immediately if such a reaction occurs and contact your hearing care professional or physician.

Mobile phone compatibility rating

Some hearing aid users have reported a buzzing sound in their hearing aids when they are using mobile phones, indicating that the mobile phone and hearing aids may not be compatible. According to the ANSI C63.19 standard (ANSI C63.19-2011 American National Standard Methods of Measurement of Compatibility Between Wireless Communications Devices and Hearing Aids), the compatibility of particular hearing aids and a mobile phone can be predicted by adding the rating for the hearing aid immunity to the rating for the mobile phone emissions. For example, the sum of the hearing aid rating of 4 (M4) and a telephone rating of 3 (M3) would result in a combined rating of 7. Any combined rating that equals at least 5 would provide “normal use”; a combined rating of 6 or greater would indicate “excellent performance.”

The immunity of these hearing aids is at least M4. The equipment performance measurements, categories and system classifications are based upon the best information available but cannot guarantee that all users will be satisfied.

- ① The performance of the individual hearing aids may vary with individual mobile phones. Therefore, please try these hearing aids with your mobile phone or, if you are purchasing a new phone, please be sure to try it with your hearing aids prior to purchase.

Tinnitus Masker

The Tinnitus noise generator is a broadband sound generator which may have been enabled in your hearing aid. It provides a means of sound enrichment that can be used as part of a personalized tinnitus management program to provide temporary relief from tinnitus. It should always be used as prescribed by your audiologist.

The underlying principle of sound enrichment is to provide supplementary noise stimulation which can help defocus your attention from your tinnitus and avoid negative reactions. Sound enrichment, coupled with instructional counseling, is an established approach to managing tinnitus.

Good health practice requires that a person reporting tinnitus have a medical evaluation by a licensed ear physician before using a sound generator. The purpose of such an evaluation is to ensure medically treatable conditions

that may be causing tinnitus are identified and treated prior to using a sound generator.

Should you develop any side effects whilst using the noise generator such as headaches, nausea, dizziness or heart palpitations or experience a decrease in auditory function, you should discontinue use and seek a medical evaluation.

According to OSHA (Occupational Safety & Health Administration, U.S. Department of Labor) regulations, the volume of the noise generator can be set to a level which could lead to permanent hearing damage when used for a prolonged period of time. Should the noise generator be set to such a level in your hearing aid, your audiologist will advise you of the maximum amount of time per day you should use the noise generator. The noise generator should never be used at uncomfortable level.

UK Responsible person and UK importer:

Sonova UK Limited
Sonova House
Lakeside Drive, Centre Park
WA1 1RX Warrington
United Kingdom

Australian Sponsor :

Sonova Australia Pty Ltd.
12 Inglewood Place, Norwest
NSW 2153
Australia



And importer for European Union :

Sonova Deutschland GmbH
Max-Eyth-Str. 20
70736 Fellbach-Oeffingen, Germany
Pat. www.sonova.com/en/intellectualproperty

Relate® is a registered trademark of Ear Professionals International LLC and is manufactured by Sonova. For assistance, if needed, or to report unexpected operations or events, please contact Sonova at information.unitron@sonova.com

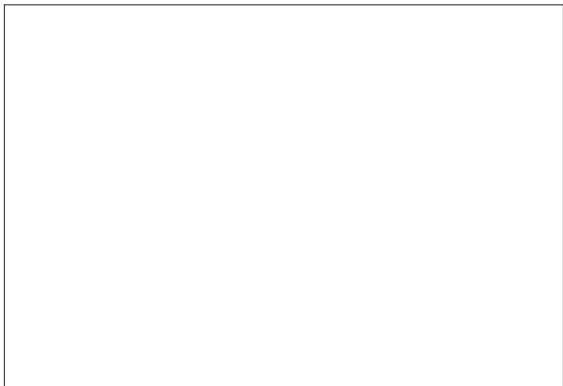

Manufacturer:
Sonova AG
Laubisrütistrasse 28
CH-8712 Stäfa
Switzerland



029-7015-02/V1.00/2025-09/CZ

